

OSRAM
 Opto Semiconductors

OSRAM Opto Semiconductors,

SFH 7710

Osa numero:

SFH 7710

Valmistaja / merkki:

OSRAM Opto Semiconductors, Inc.

Tuotteen Kuvaus

SENSOR TILT DIGITAL 10MA SMD

lomakkeissa:

 SFH 7710.pdf

RoHS-tila

 Lyijytön / RoHS -yhteensopiva

Lähetys

Hong Kong

Lähetysreitti

DHL/Fedex/TNT/UPS/EMS

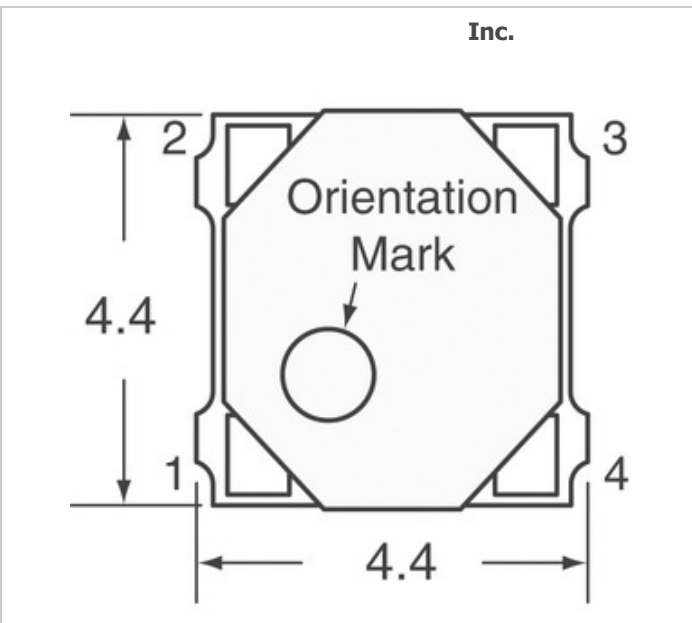

Kuva voi olla edustus. Katso tuotetiedot.

[TARJOUSPYINTÖ](#)











SFH 7710: n tekniset tiedot

OSA NUMERO	SFH 7710
VALMISTAJA	OSRAM Opto Semiconductors, Inc.
KUVAUS	SENSOR TILT DIGITAL 10MA SMD
LYIJYTÖN TILA / ROHS-TILA	Lyijytön / RoHS -yhteensopiva
TIELOLOMAKE	 SFH 7710.pdf
JÄNNITE - SUPPLY	2.3 V ~ 3.6 V
SARJA	-
PAKKAUS	Tape & Reel (TR)
PAKKAUS / CASE	4-SMD
LÄHTÖ TYYPPI	Digital, Open Drain
MUUT NIMET	475-1269-2 Q3437777 Q65110A4407 SFH 7710-Z
KÄYTTÖLÄMPÖTILA	-20°C ~ 65°C
KÄYTTÖLÄMPÖTILA ANGLE	-
ASENUSTYYPPI	Surface Mount
KOSTEUDEN HERKKYYS (MSL)	4 (72 Hours)
LYIJYTÖN TILA / ROHS-TILA	Lead free / RoHS Compliant
NYKYINEN - TUOTOS	10mA

Liittyvät tunnisteet

OSRAM Opto Semiconductors, Inc. SFH 7710	SFH 7710-jakelija	SFH 7710-toimittaja
SFH 7710 Hinta	SFH 7710-kuvat	SFH 7710-kuva
SFH 7710 PDF-tietosivu	SFH 7710 Lataa tietosivu	SFH 7710-tietolomake
SFH 7710-osake	Osta SFH 7710	Osta OSRAM Opto Semiconductors, Inc. SFH 7710
OSRAM Opto Semiconductors, Inc. SFH 7710	OSRAM Opto Semiconductors, Inc.-toimittaja	OSRAM Opto Semiconductors, Inc.-jakelija
OSRAM Opto Semiconductors, Inc. SFH 7710	OSRAM Opto Semiconductors Inc. SFH 7710	

Liittyvät tuotteet

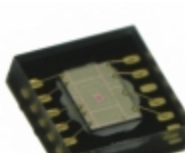
 <p>SFH 7225-Z valmistajat: OSRAM Opto Semiconductors, Inc. Kuvaus: LED YELLOW CLEAR SMD Varastossa: Out stock</p> <p>RFQ</p>	 <p>SFH 7251 valmistajat: OSRAM Opto Semiconductors, Inc. Kuvaus: EMITTER IR MULTI TOPLED Varastossa: Out stock</p> <p>RFQ</p>
 <p>SFH 757 valmistajat: International Rectifier (Infineon Technologies) Kuvaus: TRANSMITTER DIODE FIBER OPTIC Varastossa: Out stock</p> <p>RFQ</p>	 <p>SFH 7250 valmistajat: OSRAM Opto Semiconductors, Inc. Kuvaus: EMITTER IR 850NM Varastossa: Out stock</p> <p>RFQ</p>
 <p>SFH 7771 valmistajat: OSRAM Opto Semiconductors, Inc. Kuvaus: CHIP ON BOARD Varastossa: Out stock</p> <p>RFQ</p>	 <p>SFH 7770 E6 valmistajat: OSRAM Opto Semiconductors, Inc. Kuvaus: ALS, PROXIMITY SENSOR (2-IN-1) Varastossa: Out stock</p> <p>RFQ</p>
 <p>SFH 7252 valmistajat: OSRAM Opto Semiconductors, Inc. Kuvaus: MULTI TOPLED Varastossa: Out stock</p> <p>RFQ</p>	 <p>SFH 7741-Z valmistajat: OSRAM Opto Semiconductors, Inc. Kuvaus: PROXIMITY SENSOR 30MM Varastossa: Out stock</p> <p>RFQ</p>
 <p>SFH 7740-Z valmistajat: OSRAM Opto Semiconductors, Inc. Kuvaus: SENSOR OPTO REFLECTIVE 6SMD Varastossa: Out stock</p> <p>RFQ</p>	 <p>SFH 757V valmistajat: International Rectifier (Infineon Technologies) Kuvaus: TRANSMITTER DIODE FIBER OPTIC Varastossa: Out stock</p> <p>RFQ</p>
 <p>SFH 7743-Z valmistajat: OSRAM Opto Semiconductors, Inc. Kuvaus: PHOTODETECTOR SCHMITT SMD Varastossa: Out stock</p> <p>RFQ</p>	 <p>SFH 7770 valmistajat: OSRAM Opto Semiconductors, Inc. Kuvaus: LIGHT SENSOR AMBIENT SMD Varastossa: Out stock</p> <p>RFQ</p>

Tekijänoikeudet © 2020 luotettava elektronisten komponenttien jakelija - Ocean-Components.com

Sähköposti: Info@Ocean-Components.com

Osoite: Room 2102, Connaught Commercial Building, 185 Wan Chai Rd, Wan Chai, Hong Kong

