





Grayhill, Inc.

62S11-H9-050S

Osa numero:	62S11-H9-050S
Valmistaja / merkki:	Grayhill, Inc.
Tuotteen Kuvaus	ROTARY ENCODER OPTICAL 32PPR
lomakkeissa:	 62S11-H9-050S.pdf
RoHS-tila	 Lyijytön / RoHS -yhteensopiva
Lähetys	Hong Kong
Lähetysreitti	DHL/Fedex/TNT/UPS/EMS

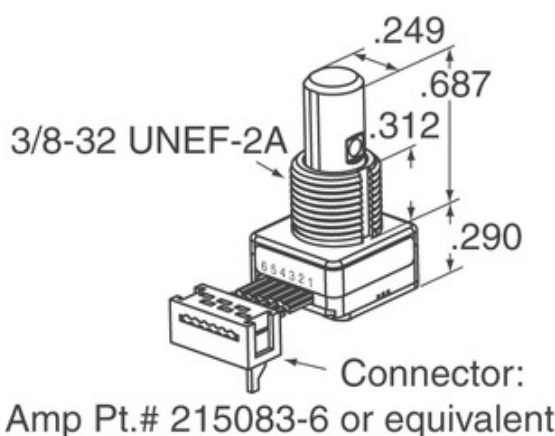
TARJOUSPYINTÖ

Kuva voi olla edustus. Katso tuotetiedot.

62S11-H9-050S: n tekniset tiedot

OSA NUMERO	62S11-H9-050S
VALMISTAJA	Grayhill, Inc.
KUVAUS	ROTARY ENCODER OPTICAL 32PPR
LYIJYTÖN TILA / ROHS-TILA	Lyijytön / RoHS -yhteensopiva
TIETOLOMAKE	 62S11-H9-050S.pdf
JÄNNITE - SUPPLY	5V
PÄÄTTYMINEN STYLE	Cable Leads
SARJA	62S
PYÖRITYKSEN LIFE (CYCLES MIN)	1M
PULSSIA PER KIERROS	32
LÄHTÖ TYYPPI	Quadrature (Incremental)
MUUT NIMET	62S11H9050S
SUUNTAUTUMINEN	Vertical
ASENNUSTYYPPI	Panel Mount
KOSTEUDEN HERKKYYS (MSL)	1 (Unlimited)
VALMISTAJAN TOIMITUSAIKA	8 Weeks
LYIJYTÖN TILA / ROHS-TILA	Lead free / RoHS Compliant
ENCODER TYPE	Optical
PIDÄKKEEN	Yes
SISÄÄNRAKENNETTU KYTKIN	Yes
ACTUATOR TYPE	1/4" Dia Flatted End

Liittyvät tunnisteet

Grayhill, Inc. 62S11-H9-050S	62S11-H9-050S-jakelija	62S11-H9-050S-toimittaja
62S11-H9-050S Hinta	62S11-H9-050S-kuvat	62S11-H9-050S-kuva
62S11-H9-050S PDF-tietosivu	62S11-H9-050S Lataa tietosivu	62S11-H9-050S-tietolomake
62S11-H9-050S-osake	Osta 62S11-H9-050S	Osta Grayhill, Inc. 62S11-H9-050S
Grayhill, Inc. 62S11-H9-050S	Grayhill, Inc.-toimittaja	Grayhill, Inc.-jakelija
Grayhill, Inc. 62S11-H9-050S	Grayhill Inc. 62S11-H9-050S	

Liittyvät tuotteet

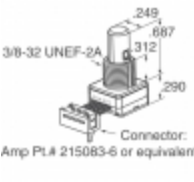
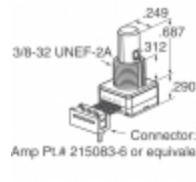
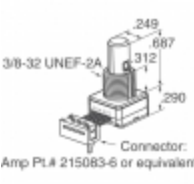
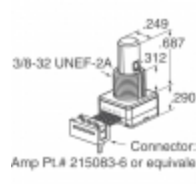
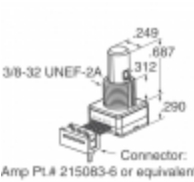
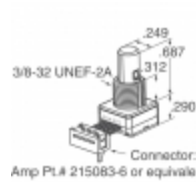
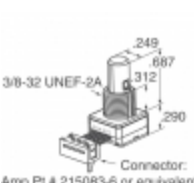
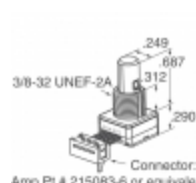
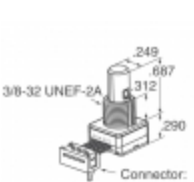
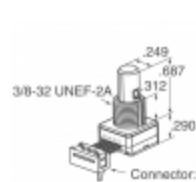
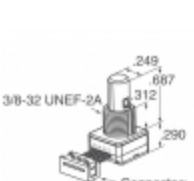
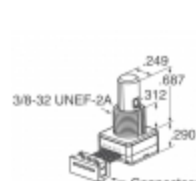
 <p>62S11-H9-040C valmistajat: Grayhill, Inc. Kuvaus: ROTARY ENCODER OPTICAL 32PPR Varastossa: Out stock</p> <p>RFQ</p>	 <p>62S11-H9-040S valmistajat: Grayhill, Inc. Kuvaus: ROTARY ENCODER OPTICAL 32PPR Varastossa: Out stock</p> <p>RFQ</p>
 <p>62S11-L0-020C valmistajat: Grayhill, Inc. Kuvaus: ROTARY ENCODER OPTICAL 32PPR Varastossa: Out stock</p> <p>RFQ</p>	 <p>62S11-H9-020C valmistajat: Grayhill, Inc. Kuvaus: ROTARY ENCODER OPTICAL 32PPR Varastossa: Out stock</p> <p>RFQ</p>
 <p>62S11-H9-PH valmistajat: Grayhill, Inc. Kuvaus: ROTARY ENCODER OPTICAL 32PPR Varastossa: Out stock</p> <p>RFQ</p>	 <p>62S11-L0-020CH valmistajat: Grayhill, Inc. Kuvaus: ROTARY ENCODER OPTICAL 32PPR Varastossa: Out stock</p> <p>RFQ</p>
 <p>62S11-H9-P valmistajat: Grayhill, Inc. Kuvaus: ROTARY ENCODER OPTICAL 32PPR Varastossa: Out stock</p> <p>RFQ</p>	 <p>62S11-H0-PH valmistajat: Grayhill, Inc. Kuvaus: ROTARY ENCODER OPTICAL 32PPR Varastossa: Out stock</p> <p>RFQ</p>
 <p>62S11-H9-060C valmistajat: Grayhill, Inc. Kuvaus: ROTARY ENCODER OPTICAL 32PPR Varastossa: Out stock</p> <p>RFQ</p>	 <p>62S11-H9-020S valmistajat: Grayhill, Inc. Kuvaus: ROTARY ENCODER OPTICAL 32PPR Varastossa: Out stock</p> <p>RFQ</p>
 <p>62S11-H9-060SH valmistajat: Grayhill, Inc. Kuvaus: ROTARY ENCODER OPTICAL 32PPR Varastossa: Out stock</p> <p>RFQ</p>	 <p>62S11-H9-025S valmistajat: Grayhill, Inc. Kuvaus: ROTARY ENCODER OPTICAL 32PPR Varastossa: Out stock</p> <p>RFQ</p>

Tekijänoikeudet © 2020 luotettava elektronisten komponenttien jakelija - Ocean-Components.com

Sähköposti: Info@Ocean-Components.com

Osoite: Room 2102, Connaught Commercial Building, 185 Wan Chai Rd, Wan Chai, Hong Kong

