

PV5 SERIES ANTI-VANDAL SWITCH

ANTI-VANDAL SWITCHES
DETECTOR SWITCHES
DIP SWITCHES
KEYLOCK SWITCHES
NAVIGATION SWITCHES
PUSHBUTTON SWITCHES
ROCKER SWITCHES
ROTARY SWITCHES
SLIDE SWITCHES
SNAP ACTION SWITCHES
TACTILE SWITCHES
TOGGLE SWITCHES
CAP OPTIONS



APPLICATIONS / MARKETS



RoHS

SPECIFICATIONS

Electrical Rating: 2A, 36VDC
Mechanical Life: 1,000,000 Cycles
Electrical Life: 200,000 Cycles
Contact Resistance: 50mΩ Max.
Insulation Resistance: 1000 MΩ Min.
Dielectric Strength: 2,000VAC
Operating/Storage Temperature: -25°C to 55°C
Travel: 2.50mm
Moisture Protection: IP65
Contact Arrangement: SPST Off-(On)
Actuation Force: 5 N
Panel Thickness: 1-5mm
Mounting Nut Torque: 0.3Nm

FEATURES & BENEFITS

- Multiple actuator finish options
- Solder or screw termination options
- Raised or domed actuator options
- IP65 rated

PART NUMBER CONFIGURATOR

Series	Actuator Options	Terminal Options	Function Options	Rating Options	Body Finish Options	Actuator Finish Options	Contact Material Options
<input type="text" value="PV5"/>	<input type="text" value="H - Raised
S - Domed"/>	<input type="text" value="2 - Solder
6 - Screw"/>	<input type="text" value="4 - 1 Pole
Off - (On)*"/>	<input type="text" value="0 - 2A, 36VDC"/>	<input type="text" value="N - Nickel
S - Polished Stainless
1 - Black Anodized"/>	<input type="text" value="1 - Black
2 - White
6 - Yellow
7 - Blue
8 - Green
9 - Red
N - Nickel
S - Polished Stainless"/>	<input type="text" value="NONE - Silver
G - Gold"/>

NOTES:
 *(ON) Denotes function is momentary

Specifications subject to change without notice



E-SWITCH®

www.e-switch.com

800.867.2717

1

PV5 SERIES ANTI-VANDAL SWITCH

BODY DIMENSIONS - FLATS

SOLDER TERMINATION

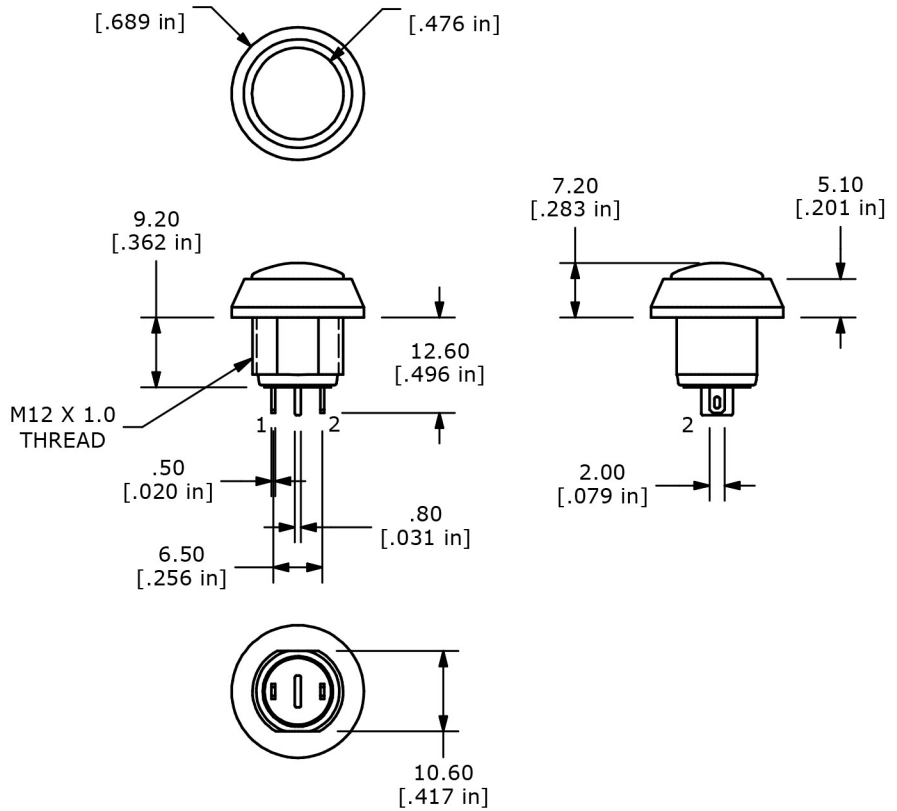
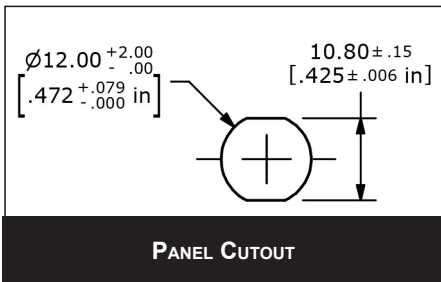
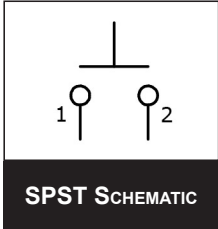

SCREW TERMINATION

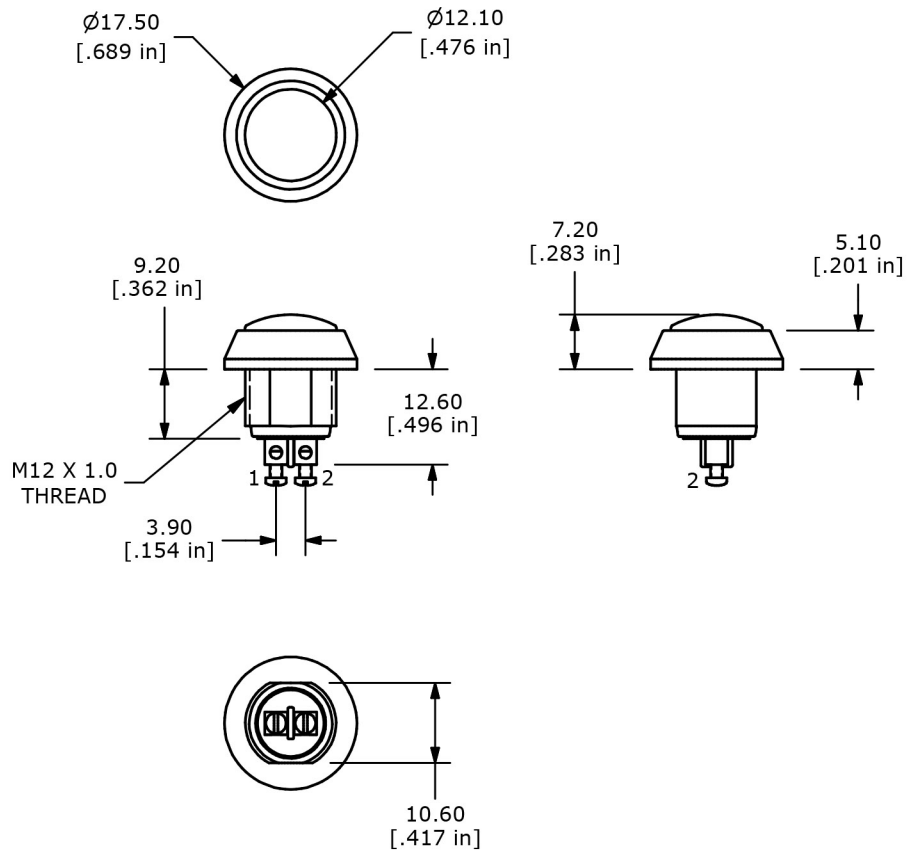
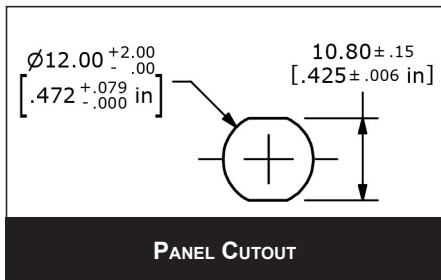
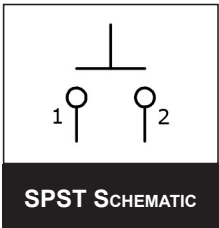

PV5 SERIES ANTI-VANDAL SWITCH

BODY DIMENSIONS - NICKEL, BLACK ANODIZED OR STAINLESS

SOLDER TERMINATION

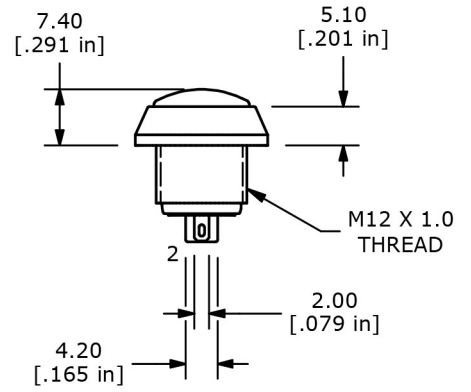
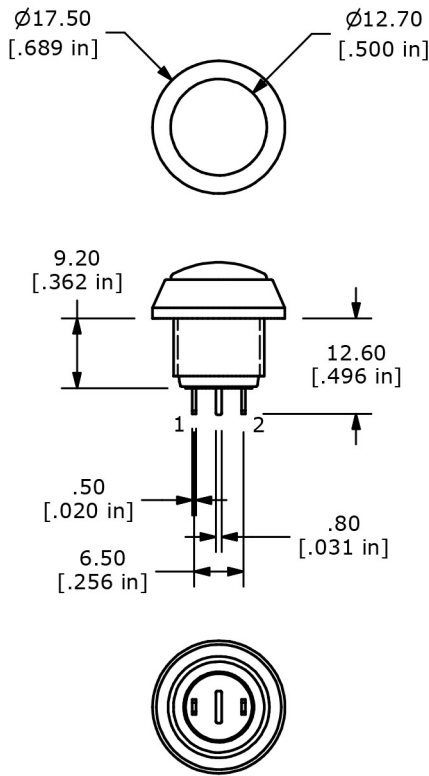
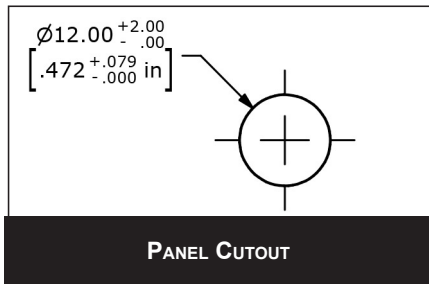
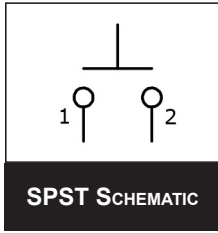

SCREW TERMINATION

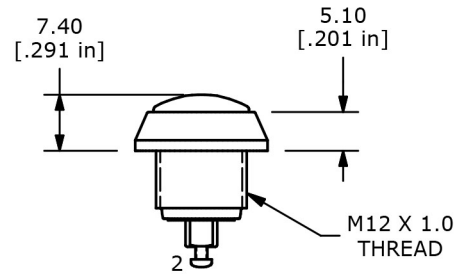
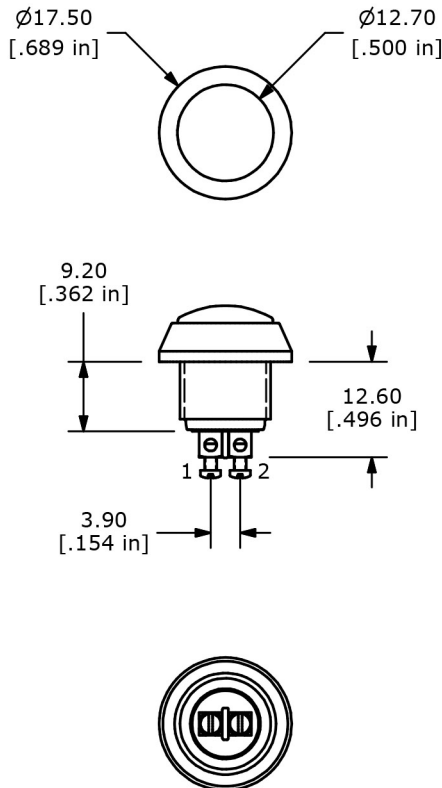
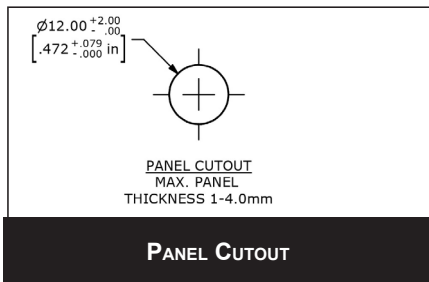
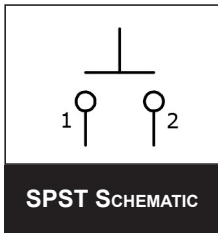

PV5 SERIES ANTI-VANDAL SWITCH

ACTUATOR OPTIONS

NICKEL OR STAINLESS

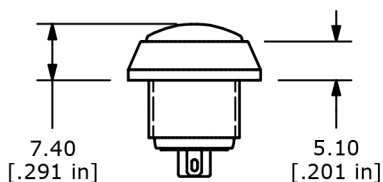
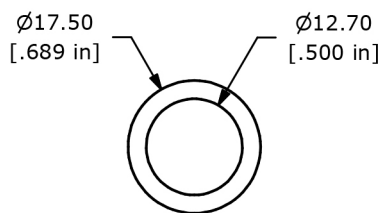

DOMED ACTUATOR

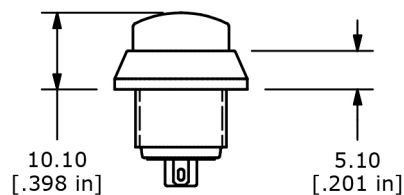
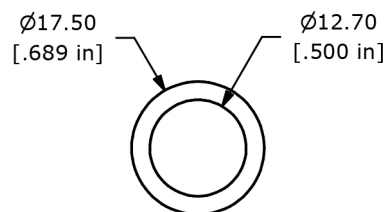

RAISED ACTUATOR

BLACK, WHITE, YELLOW, BLUE, GREEN OR RED

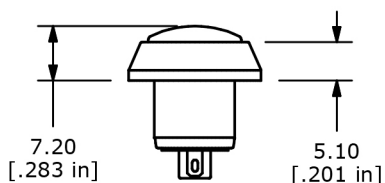
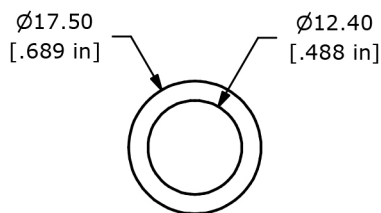

DOMED ACTUATOR

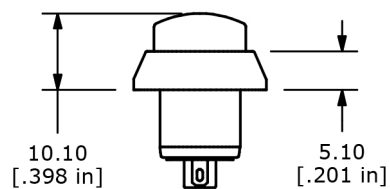
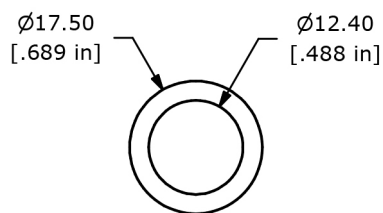

RAISED ACTUATOR

