

Noise Filter

S8V-NF (Single-phase 250 V 3 A / 6 A Type)

DIN Rail Mounting Type Ideal for Control Panels
Featuring a Slim Design that Saves Space
Push-In Connections for Safe and Easy Wiring



- 150 kHz to 1 MHz high attenuation
- Operation possible at ambient temperatures from -40 to 85°C
- Complies with RoHS directives
- Certification for 3,000 m altitude (UL/EN 60939)
- Five years Warranty *1

*1. Refer to *Period and Terms of Warranty* on page 9 for details.

⚠ Refer to *Safety Precautions* on page 6.

Model Number Structure

Model Number Legend

Note: Not all combinations are possible. Refer to List of *Model number* in *Ordering Information*, below.

S8V-NF S 2 □ □
 1 2 3

1. Input type

S: Single-phase AC/DC

2. Rated voltage

2: 250 VAC/250 VDC

3. Rated current

03: 3 A

06: 6 A

Ordering Information

Note: For details on normal stock models, contact your nearest OMRON representative.

Rated voltage	Rated current	Model number
250 VAC	3 A	S8V-NFS203
250 VDC	6 A	S8V-NFS206

S8V-NF

Ratings and Characteristics

Item	Rated current Rated voltage	3 A	6 A
		Single-phase 250 VAC 50/60 Hz *1, 250 VDC	
I/O characteristics	Leakage current	1.0 mA max. (250 VAC/60 Hz)	
	DC resistance	110 mΩ max.	
	Attenuation	25 dB min. (Common Mode: 0.1 to 10 MHz, Normal Mode: 0.2 to 30 MHz)	
	Withstand voltage	2.5 kVAC for 1 min. (between line and ground), current cutoff 10 mA	
	Insulation resistance	100 MΩ min. (500 VDC, 1 min.)	
Environment	Ambient operating temperature	-40 to 85°C (Derating is required. Refer to <i>Engineering Data</i>) (with no condensation or icing)	
	Derating start temperature	+85°C	+60°C
	Storage temperature	-40 to 85°C (with no condensation or icing)	
	Ambient operating humidity	95% (Storage humidity: 95% max.)	
	Vibration resistance	10 to 55 Hz, maximum 5 G, 0.42 mm half amplitude for 2 h each in X, Y, and Z directions	
	Shock resistance	150 m/s ² , 3 times each in ±X, ±Y, ±Z directions	
Construction	Weight	140 g max.	
	Degree of protection	IP20 by EN/IEC 60529	
Standards	Safety standards	UL 60939 (Recognition) OVC III (≤3000 m) Pol2 CSA C22.2 No.8 EN 60939 OVC III (≤3000 m) Pol2 ENEC *2 EAC (TR CU 004 / 2011)	

*1. If the input is connected to a UPS, do not connect a UPS with a square-wave output. Doing so will cause the internal temperature of the product to increase, possibly causing smoking or damage.

*2. ENEC is a certification that makes product distribution to EU member countries, EFTA (European Free Trade Association) member countries, and Eastern European countries possible.

Connections

Circuit Diagram

S8V-NFS203
S8V-NFS206

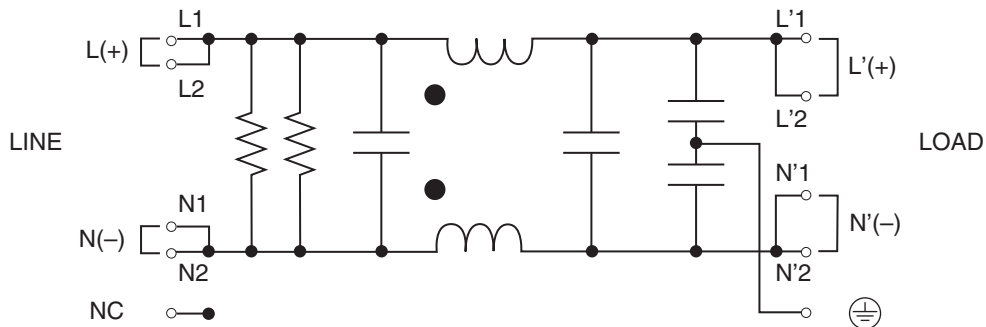

Construction and Nomenclature

Nomenclature

S8V-NFS203, S8V-NFS206

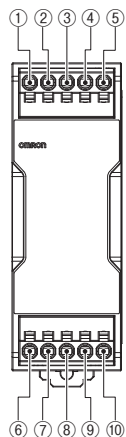

No.	Terminal name	Name	Function
1	L1	Line terminals	Connect the input lines to these terminals. *1
2	L2		
3	N1		
4	N2		
5	NC	No connection	Do not wire.
6	L'1	Load terminals	Connect the output lines to these terminals. *1
7	L'2		
8	N'1		
9	N'2		
10	PE	Protective Earth terminal (PE)	Connect the ground line to this terminal. *2

*1. Wiring is generally laid out so that the line terminal is connected to the input side and the load terminal is connected to the output side, though use in the opposite direction is also possible.

Note that if the input and output are wired in reverse, the appropriate attenuation characteristics may not be obtained.

*2. This is the protective earth terminal specified in the safety standards. Always ground this terminal.

Engineering Data

Derating Curves

S8V-NFS203

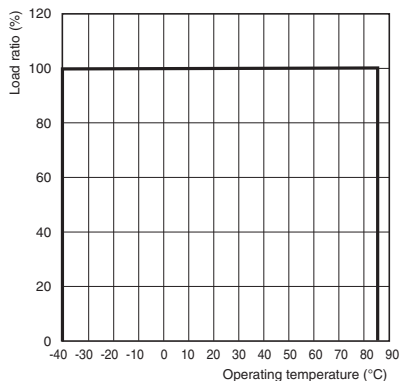

Note: If using at an altitude of 2000 m to 3000 m, multiply the above derating curve by 0.8 to reduce the load. (Does not apply for face-up mounting)

S8V-NFS206

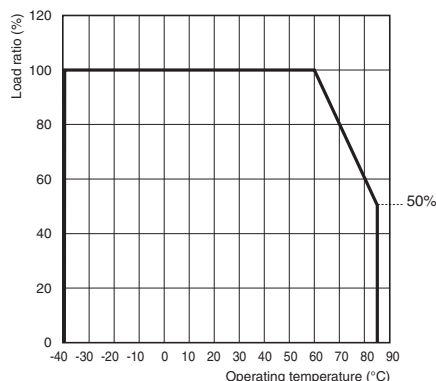

Note: If using at an altitude of 2000 m to 3000 m, multiply the above derating curve by 0.8 to reduce the load. (Does not apply for face-up mounting)

Attenuation Frequency Characteristics (Typical example)

S8V-NFS203

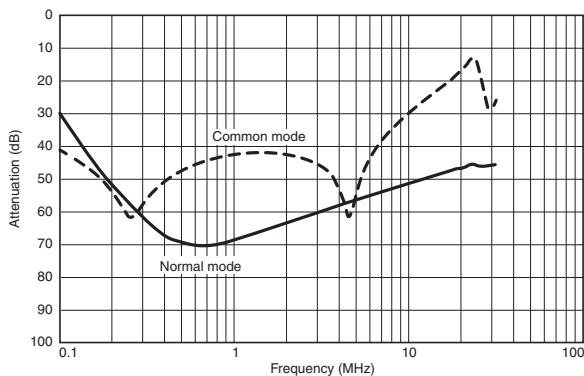

S8V-NFS206

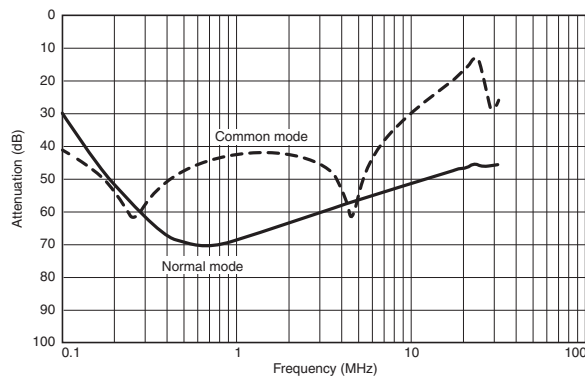

The above characteristics are data acquired by the following measurement circuits.

Common mode

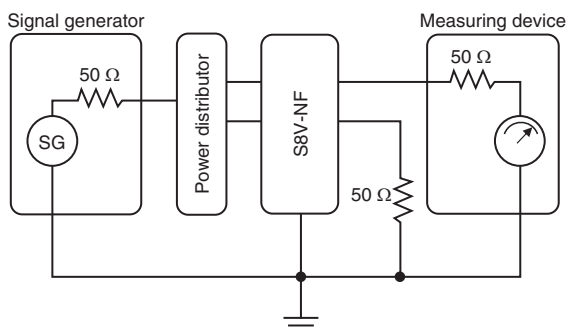

Normal mode

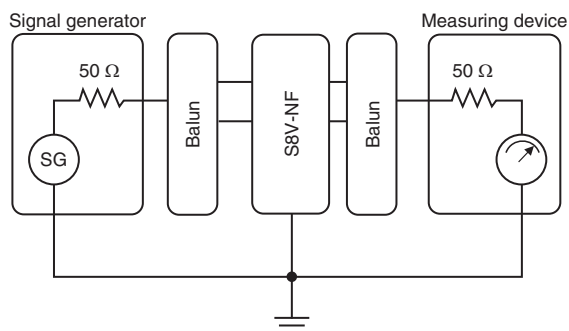

Note: The noise filter attenuation characteristics are measured under a constant I/O impedance of 50 Ω. When used attached to actual equipment, the power line impedance varies depending on the wiring method. Therefore, attenuation characteristics may not match those listed in the catalog.

S8V-NF

Dimensions

(Unit: mm)

S8V-NFS203
S8V-NFS206

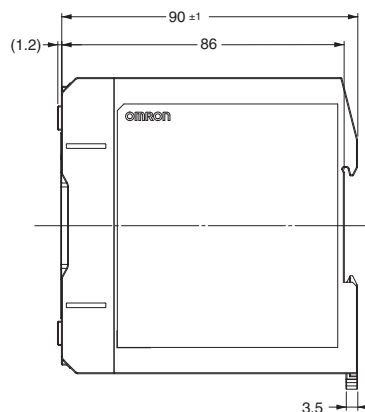
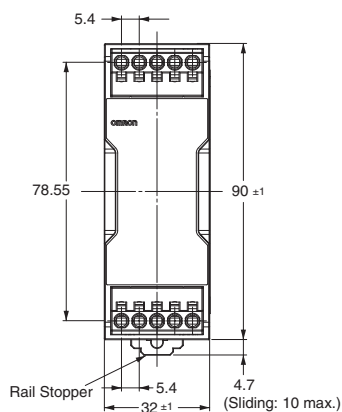

Mounting Brackets

Name	Model number
Front-mounting bracket	S82Y-VS10F
Side-mounting bracket	S82Y-VS10S

Name	Model number	Dimensions	Appearance
Front-mounting bracket	S82Y-VS10F		
Side-mounting bracket	S82Y-VS10S		<div style="display: flex; justify-content: space-around;"> <div style="text-align: center;"> <p>Left-side mounting</p> </div> <div style="text-align: center;"> <p>Right-side mounting</p> </div> </div>

DIN Rails (Order Separately)

(Unit: mm)

Mounting Rail (Material: Aluminum)

PFP-100N
PFP-50N

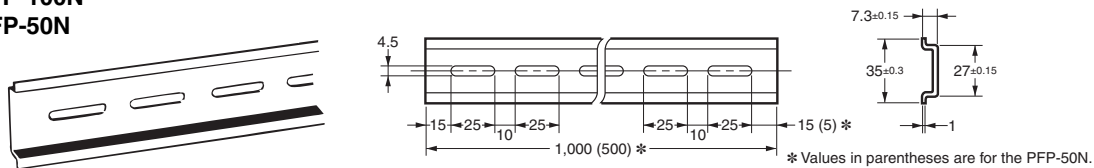

Mounting Rail (Material: Aluminum)

PFP-100N2

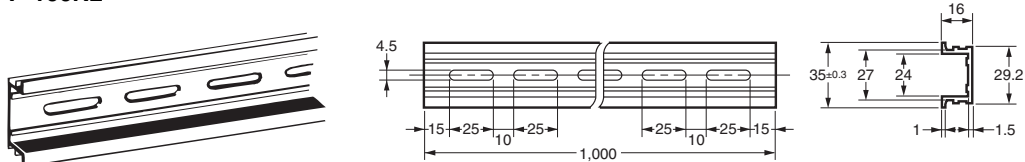

End Plate

PFP-M

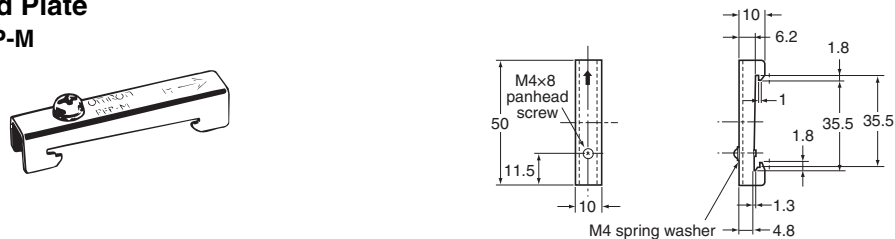





Note: If there is a possibility that the Unit will be subject to vibration or shock, use a steel DIN Rail. Otherwise, metallic filings may result from aluminum abrasion.

Safety Precautions

Warning Indications

 WARNING	Indicates a potentially hazardous situation which, if not avoided, will result in minor or moderate injury, or may result in serious injury or death. Additionally, there may be significant property damage.
 CAUTION	Indicates a potentially hazardous situation which, if not avoided, may result in minor or moderate injury or in property damage.
Precautions for Safe Use	Supplementary comments on what to do or avoid doing, to use the product safely.
Precautions for Correct Use	Supplementary comments on what to do or avoid doing, to prevent failure to operate, malfunction or undesirable effect on product performance.

Meaning of Product Safety Symbols

	Used to warn of the risk of electric shock under specific conditions.
	Used to warn of the risk of minor injury caused by high temperatures.
	Used to indicate prohibition when there is a risk of minor injury from electrical shock or other source if the product is disassembled.
	Used for general mandatory action precautions for which there is no specified symbol.

WARNING

The electrical wire may come out and an electric shock may be caused. Insert the solid wire or ferrule straight into the terminal block until the end touches the terminal block.



CAUTION

Minor electric shock, fire, or product failure may occasionally occur. Do not disassemble, modify, or repair the product or touch the interior of the product.



Minor burns may occasionally occur. Do not touch the product while power is being supplied or immediately after power is turned OFF.



Minor injury due to electric shock may occasionally occur. Do not touch the terminals while power is being supplied.



Minor electric shock, fire, or product failure may occasionally occur. Do not allow any pieces of metal, conductors, or cuttings from installation work to enter the product.



Fire or product failure may occasionally occur. Do not use on the secondary side (output side) of inverters, etc.



Precautions for Safe Use

Installation Environment

- Do not use the product in locations subject to shocks or vibrations. In particular, install the product as far away as possible from contactors or other devices that are a vibration source.
- Install the product well away from any sources of strong, high-frequency noise and surge.

Ambient Operating and Storage Environments

- Store the product at a temperature of -40 to 85°C and a humidity of 95% or less.
- Do not use the product in areas outside the derating curve otherwise, internal parts may occasionally deteriorate or be damaged.
- Use the product at a humidity of 95% max.
- Do not use the product in locations subject to direct sunlight.
- Do not use locations where liquids, foreign matter, or corrosive gases may enter the interior of the product.

Mounting

- Take adequate measures to ensure proper heat dissipation to increase the long-term reliability of the product. Be sure to allow convection in the atmosphere around devices when mounting. Do not use in locations where the ambient temperature exceeds the range of the derating curve.
- When cutting out holes for mounting, make sure that cuttings do not enter the interior of the product.

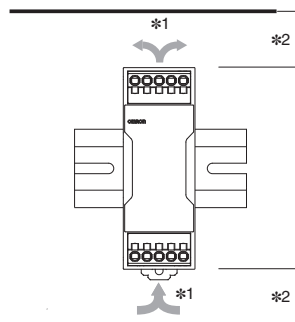

*1. Convection of air
*2. Vertical separation: 25 mm or more

(A) Standard (Vertical) mounting

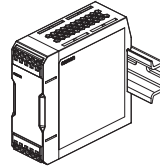

(B) Face-up mounting

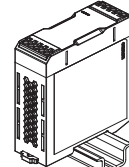

(C) Front, Side-by-side mounting

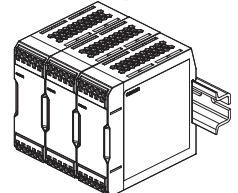

Note: Horizontal separation

(A), (B): 15 mm or more

(C) : 0 mm or more and 15 mm or less.

Wiring

- Connect the ground completely. A protective earthing terminal stipulated in safety standards is used. Electric shock or malfunction may occur if the ground is not connected completely.
- When you insert wires or insert a screwdriver into a release hole, do not press down on the terminal block with a force of 40 N or greater.
- Do not wire anything to the release holes.
- Do not tilt or twist a flat-blade screwdriver while it is inserted into a release hole on the terminal block. The terminal block may be damaged.
- Insert a flat-blade screwdriver into the release holes at an angle. The terminal block may be damaged if you insert the screwdriver straight in.
- Do not allow the flat-blade screwdriver to fall out while it is inserted into a release hole.
- Do not bend a wire past its natural bending radius or pull on it with excessive force. This may cause a wire to be broken.
- Do not insert more than one wire into each terminal insertion hole.
- Do not pre-solder the ends of the wires. Doing so will inhibit proper connection.
- Be sure to remove the sheet covering the product for machining before power-ON so that it does not interfere with heat dissipation.
- If there is a possibility of vibration or shock, please use wires and stranded wires with ferrules.
- To prevent wiring materials from ignition or smoking, confirm wire ratings and use the wiring materials given in the following table.

Terminal	Model number	Recommended wire gauge	
		(mm ²)	(AWG)
I/O terminals	S8V-NFS203	0.5 to 2.5	20 to 14
	S8V-NFS206	0.75 to 2.5	18 to 14
PE (protective earth) terminal	S8V-NFS203 S8V-NFS206	2 to 2.5	14

- Crossover wiring can be used for this product.
- However, do not allow the total steady-state current to terminals to exceed 10 A.
The above table gives the recommended wires for one product.
- When using crossover wiring, select wiring materials suitable for the total current that will flow to terminals.

Stripping length

Recommended Wire	Stripping length (Ferrules not used)
0.34 to 1.5 mm ² /AWG20 to 16	8 mm
2 to 2.5 mm ² /AWG14	10 mm

Precautions for Correct Use

DIN Rail Mounting

To mount the Block on a DIN Rail, hook portion (A) of the Block onto the rail and press the Block in direction (B).

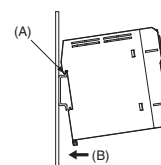

To dismantle the Block, pull down portion (C) with a flat-blade screwdriver and pull out the Block.

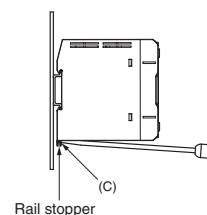

Connecting Wires to the Push-In Plus Terminal Block Part Names of the Terminal Block

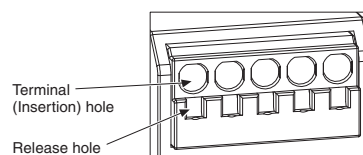

Connecting Wires with Ferrules and Solid Wires

Insert the solid wire or ferrule straight into the terminal block until the end touches the terminal block.

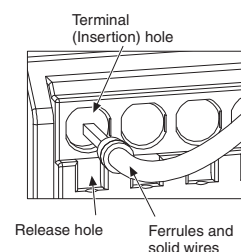

- If a wire is difficult to connect because it is too thin, use a flat-blade screwdriver in the same way as when connecting stranded wire.

Connecting Stranded Wires

Use the following procedure to connect the wires to the terminal block.

1. Hold a flat-blade screwdriver at an angle and insert it into the release hole.
The angle should be between 10° and 15°. If the flat-blade screwdriver is inserted correctly, you will feel the spring in the release hole.
2. With the flat-blade screwdriver still inserted into the release hole, insert the wire into the terminal hole until it strikes the terminal block.
3. Remove the flat-blade screwdriver from the release hole.

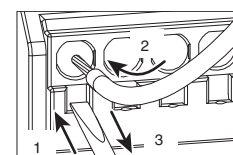
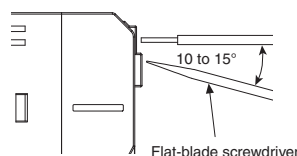

Checking Connections

- After the insertion, pull gently on the wire to make sure that it will not come off and the wire is securely fastened to the terminal block
- If you use a ferrule with a conductor length of 10 mm, part of the conductor may be visible after the ferrule is inserted into the terminal block, but the product insulation distance will still be satisfied.

Removing Wires from the Push-In Plus Terminal Block

Use the following procedure to remove wires from the terminal block. The same method is used to remove stranded wires, solid wires, and ferrules.

1. Hold a flat-blade screwdriver at an angle and insert it into the release hole.
2. With the flat-blade screwdriver still inserted into the release hole, remove the wire from the terminal insertion hole.
3. Remove the flat-blade screwdriver from the release hole.

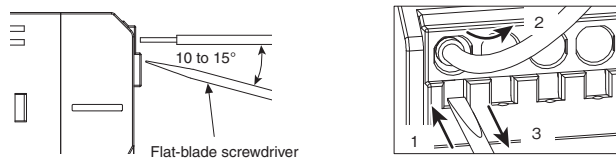

Recommended Ferrules and Crimping Tools

Recommended Ferrules

Applicable wire		Ferrule Conductor length (mm)	Stripping length (mm) (Ferrules used)	Recommended ferrules		
(mm ²)	(AWG)			Manufactured by Phoenix Contact	Manufactured by Weidmuller	Manufactured by Wago
0.50	20	8	10	AI 0,5-8	H0.5/14	FE-0.5-8N-WH
		10	12	AI 0,5-10	H0.5/16	FE-0.5-10N-WH
0.75	18	8	10	AI 0,75-8	H0.75/14	FE-0.75-8N-GY
		10	12	AI 0,75-10	H0.75/16	FE-0.75-10N-GY
1/1.25	18/17	8	10	AI 1-8	H1.0/14	FE-1.0-8N-RD
		10	12	AI 1-10	H1.0/16	FE-1.0-10N-RD
1.25/1.5	17/16	8	10	AI 1,5-8	H1.5/14	FE-1.5-8N-BK
		10	12	AI 1,5-10	H1.5/16	FE-1.5-10N-BK
2.5	14	10	12	AI 2,5-10	H2.5/16DS	FE-2.5-10N-BU
Recommended crimp tool				CRIMPFOX6 CRIMPFOX6T-F CRIMPFOX10S	PZ6 roto	Variocrimp4

Note: 1. Make sure that the outer diameter of the wire is smaller than the inner diameter of the insulating sleeve of the recommended ferrule.

2. Make sure that the ferrule processing dimensions conform to the following figure.

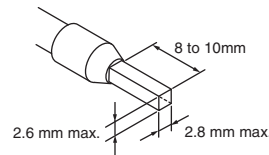

Recommended Flat-blade Screwdriver

Use a flat-blade screwdriver to connect and remove wires. Use the following flat-blade screwdriver.

The following table shows manufacturers and models as of 2015/Dec.

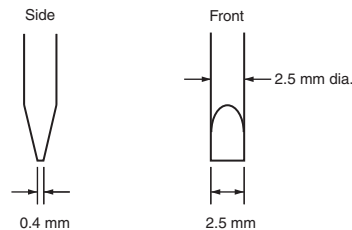

Model number	Manufacturer
ESD 0,40x2,5	Wera
SZS 0,4x2,5 SZF 0-0,4x2,5 *	Phoenix Contact
0.4x2.5x75 302	Wiha
AEF.2,5x75	Facom
210-719	Wago
SDI 0.4x2.5x75	Weidmuller

* OMRON's exclusive purchase model XW4Z-00B is available to order as SZF 0-0,4x2,5 (manufactured by Phoenix Contact).

Period and Terms of Warranty

Warranty Period

The product warranty is valid for a period of five years from the date of shipment from the factory.

Terms of Warranty

The warranty is valid only for the following operating conditions.

1. Average ambient operating temperature of the product: 40°C max. (See note.)
2. Average load rate of 80% max. (See note.)
3. Mounting method: Standard mounting

Note: The maximum ratings must be within the derating curve.

If the product fails for reasons attributable to OMRON within the above warranty period, OMRON will repair or replace the faulty part of the product at the place of purchase or the place where the product delivered without charge.

This warranty does not cover the following types of failures.

- (1) Failures that result from handling or operation of the product under conditions or in environments that are not given in this document and not given in any other specifications exchanged between OMRON and the customer
 - (2) Failures that originate in causes other than the delivered product itself
 - (3) Failures caused by disassembly, modification, or repair of the product by anyone other than OMRON
 - (4) Failures caused by applications or uses for which the product was not originally intended.
 - (5) Failures caused by factors that could not be anticipated with the scientific or technical knowledge available when the product was shipped.
 - (6) Failures caused by other causes for which OMRON is not responsible, such as natural disasters and other acts of God.
- This warranty is limited to the individual product that was delivered and does not cover any secondary, subsequent, or related damages.

Terms and Conditions Agreement

Read and understand this catalog.

Please read and understand this catalog before purchasing the products. Please consult your OMRON representative if you have any questions or comments.

Warranties.

(a) Exclusive Warranty. Omron's exclusive warranty is that the Products will be free from defects in materials and workmanship for a period of twelve months from the date of sale by Omron (or such other period expressed in writing by Omron). Omron disclaims all other warranties, express or implied.

(b) Limitations. OMRON MAKES NO WARRANTY OR REPRESENTATION, EXPRESS OR IMPLIED, ABOUT NON-INFRINGEMENT, MERCHANTABILITY OR FITNESS FOR A PARTICULAR PURPOSE OF THE PRODUCTS. BUYER ACKNOWLEDGES THAT IT ALONE HAS DETERMINED THAT THE PRODUCTS WILL SUITABLY MEET THE REQUIREMENTS OF THEIR INTENDED USE.

Omron further disclaims all warranties and responsibility of any type for claims or expenses based on infringement by the Products or otherwise of any intellectual property right. (c) Buyer Remedy. Omron's sole obligation hereunder shall be, at Omron's election, to (i) replace (in the form originally shipped with Buyer responsible for labor charges for removal or replacement thereof) the non-complying Product, (ii) repair the non-complying Product, or (iii) repay or credit Buyer an amount equal to the purchase price of the non-complying Product; provided that in no event shall Omron be responsible for warranty, repair, indemnity or any other claims or expenses regarding the Products unless Omron's analysis confirms that the Products were properly handled, stored, installed and maintained and not subject to contamination, abuse, misuse or inappropriate modification. Return of any Products by Buyer must be approved in writing by Omron before shipment. Omron Companies shall not be liable for the suitability or unsuitability or the results from the use of Products in combination with any electrical or electronic components, circuits, system assemblies or any other materials or substances or environments. Any advice, recommendations or information given orally or in writing, are not to be construed as an amendment or addition to the above warranty.

See <http://www.omron.com/global/> or contact your Omron representative for published information.

Limitation on Liability; Etc.

OMRON COMPANIES SHALL NOT BE LIABLE FOR SPECIAL, INDIRECT, INCIDENTAL, OR CONSEQUENTIAL DAMAGES, LOSS OF PROFITS OR PRODUCTION OR COMMERCIAL LOSS IN ANY WAY CONNECTED WITH THE PRODUCTS, WHETHER SUCH CLAIM IS BASED IN CONTRACT, WARRANTY, NEGLIGENCE OR STRICT LIABILITY.

Further, in no event shall liability of Omron Companies exceed the individual price of the Product on which liability is asserted.

Suitability of Use.

Omron Companies shall not be responsible for conformity with any standards, codes or regulations which apply to the combination of the Product in the Buyer's application or use of the Product. At Buyer's request, Omron will provide applicable third party certification documents identifying ratings and limitations of use which apply to the Product. This information by itself is not sufficient for a complete determination of the suitability of the Product in combination with the end product, machine, system, or other application or use. Buyer shall be solely responsible for determining appropriateness of the particular Product with respect to Buyer's application, product or system. Buyer shall take application responsibility in all cases.

NEVER USE THE PRODUCT FOR AN APPLICATION INVOLVING SERIOUS RISK TO LIFE OR PROPERTY OR IN LARGE QUANTITIES WITHOUT ENSURING THAT THE SYSTEM AS A WHOLE HAS BEEN DESIGNED TO ADDRESS THE RISKS, AND THAT THE OMRON PRODUCT(S) IS PROPERLY RATED AND INSTALLED FOR THE INTENDED USE WITHIN THE OVERALL EQUIPMENT OR SYSTEM.

Programmable Products.

Omron Companies shall not be responsible for the user's programming of a programmable Product, or any consequence thereof.

Performance Data.

Data presented in Omron Company websites, catalogs and other materials is provided as a guide for the user in determining suitability and does not constitute a warranty. It may represent the result of Omron's test conditions, and the user must correlate it to actual application requirements. Actual performance is subject to the Omron's Warranty and Limitations of Liability.

Change in Specifications.

Product specifications and accessories may be changed at any time based on improvements and other reasons. It is our practice to change part numbers when published ratings or features are changed, or when significant construction changes are made. However, some specifications of the Product may be changed without any notice. When in doubt, special part numbers may be assigned to fix or establish key specifications for your application. Please consult with your Omron's representative at any time to confirm actual specifications of purchased Product.

Errors and Omissions.

Information presented by Omron Companies has been checked and is believed to be accurate; however, no responsibility is assumed for clerical, typographical or proofreading errors or omissions.

OMRON Corporation Industrial Automation Company
Kyoto, JAPAN

Contact: www.ia.omron.com

Regional Headquarters

OMRON EUROPE B.V.

Wegalaan 67-69, 2132 JD Hoofddorp
The Netherlands

Tel: (31)2356-81-300/Fax: (31)2356-81-388

OMRON ELECTRONICS LLC

2895 Greenspoint Parkway, Suite 200
Hoffman Estates, IL 60169 U.S.A.

Tel: (1) 847-843-7900/Fax: (1) 847-843-7787

OMRON ASIA PACIFIC PTE. LTD.

No. 438A Alexandra Road # 05-05/08 (Lobby 2),
Alexandra Technopark,
Singapore 119967

Tel: (65) 6835-3011/Fax: (65) 6835-2711

OMRON (CHINA) CO., LTD.

Room 2211, Bank of China Tower,
200 Yin Cheng Zhong Road,
PuDong New Area, Shanghai, 200120, China

Tel: (86) 21-5037-2222/Fax: (86) 21-5037-2200

Authorized Distributor:

© OMRON Corporation 2017 All Rights Reserved.
In the interest of product improvement,
specifications are subject to change without notice.

CSM_1_1_1117
Cat. No. **T212-E1-01**

1117 (1117)