



Grayhill, Inc.

## 62S11-H9-P

Osa numero:

62S11-H9-P

Valmistaja / merkki:

Grayhill, Inc.

Tuotteen Kuvaus

ROTARY ENCODER OPTICAL 32PPR

lomakkeissa:

 62S11-H9-P.pdf

RoHS-tila

 Lyijytön / RoHS -yhteensopiva

Lähetys

Hong Kong

Lähetysreitti

DHL/Fedex/TNT/UPS/EMS

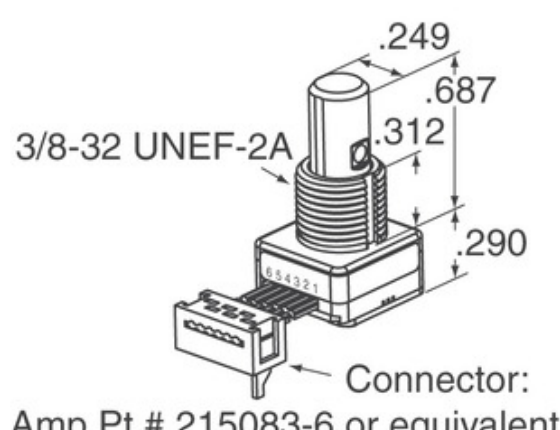
**TARJOUSPYNTÖ**

Kuva voi olla edustus. Katso tuotetiedot.



### 62S11-H9-P: n tekniset tiedot

OSA NUMERO	62S11-H9-P
VALMISTAJA	Grayhill, Inc.
KUVAUS	ROTARY ENCODER OPTICAL 32PPR
LYIJYTÖN TILA / ROHS-TILA	Lyijytön / RoHS -yhteensopiva
TIETOLOMAKE	 62S11-H9-P.pdf
JÄNNITE - SUPPLY	5V
PÄÄTTYMINEN STYLE	PC Pin
SARJA	62S
PYÖRITYKSEN LIFE (CYCLES MIN)	1M
PULSSIA PER KIERROS	32
LÄHTÖ TYYPPI	Quadrature (Incremental)
MUUT NIMET	62S11H9P
SUUNTAUTUMINEN	Vertical
ASENNUSTYYPPI	PCB, Through Hole
KOSTEUDEN HERKKYYS (MSL)	1 (Unlimited)
VALMISTAJAN TOIMITUSAIKA	8 Weeks
LYIJYTÖN TILA / ROHS-TILA	Lead free / RoHS Compliant
ENCODER TYPE	Optical
PIDÄKKEEN	Yes
SISÄÄNRAKENNETTU KYTKIN	Yes
ACTUATOR TYPE	1/4" Dia Flatted End

### Liittyvät tunnisteet

Grayhill, Inc. 62S11-H9-P	62S11-H9-P-jakelija	62S11-H9-P-toimittaja
62S11-H9-P Hinta	62S11-H9-P-kuvat	62S11-H9-P-kuva
62S11-H9-P PDF-tietosivu	62S11-H9-P Lataa tietosivu	62S11-H9-P-tietolomake
62S11-H9-P-osake	Osta 62S11-H9-P	Osta Grayhill, Inc. 62S11-H9-P
Grayhill, Inc. 62S11-H9-P	Grayhill, Inc.-toimittaja	Grayhill, Inc.-jakelija
Grayhill, Inc. 62S11-H9-P	Grayhill Inc. 62S11-H9-P	

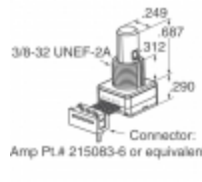
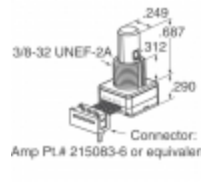
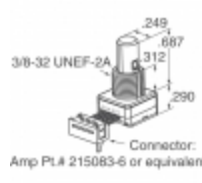
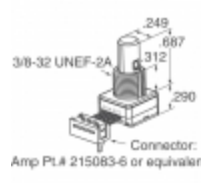
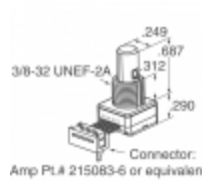
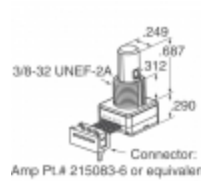
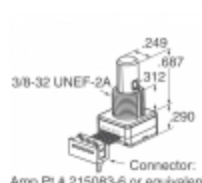
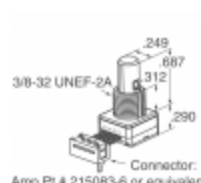
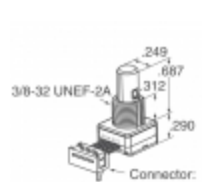
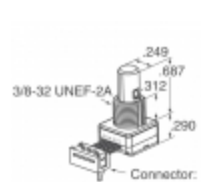
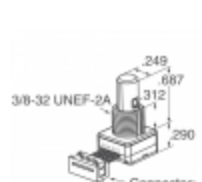
### Liittyvät tuotteet

 <p><b>62S11-H9-025S</b> valmistajat: Grayhill, Inc. Kuvaus: ROTARY ENCODER OPTICAL 32PPR Varastossa: Out stock</p> <p><b>RFQ</b></p>	 <p><b>62S11-H9-060SH</b> valmistajat: Grayhill, Inc. Kuvaus: ROTARY ENCODER OPTICAL 32PPR Varastossa: Out stock</p> <p><b>RFQ</b></p>
 <p><b>62S11-H9-050S</b> valmistajat: Grayhill, Inc. Kuvaus: ROTARY ENCODER OPTICAL 32PPR Varastossa: Out stock</p> <p><b>RFQ</b></p>	 <p><b>62S11-L0-055C</b> valmistajat: Grayhill, Inc. Kuvaus: ROTARY ENCODER OPTICAL 32PPR Varastossa: Out stock</p> <p><b>RFQ</b></p>
 <p><b>62S11-L0-020CH</b> valmistajat: Grayhill, Inc. Kuvaus: ROTARY ENCODER OPTICAL 32PPR Varastossa: Out stock</p> <p><b>RFQ</b></p>	 <p><b>62S11-H9-PH</b> valmistajat: Grayhill, Inc. Kuvaus: ROTARY ENCODER OPTICAL 32PPR Varastossa: Out stock</p> <p><b>RFQ</b></p>
 <p><b>62S11-L0-020C</b> valmistajat: Grayhill, Inc. Kuvaus: ROTARY ENCODER OPTICAL 32PPR Varastossa: Out stock</p> <p><b>RFQ</b></p>	 <p><b>62S11-H9-060C</b> valmistajat: Grayhill, Inc. Kuvaus: ROTARY ENCODER OPTICAL 32PPR Varastossa: Out stock</p> <p><b>RFQ</b></p>
 <p><b>62S11-H9-040C</b> valmistajat: Grayhill, Inc. Kuvaus: ROTARY ENCODER OPTICAL 32PPR Varastossa: Out stock</p> <p><b>RFQ</b></p>	 <p><b>62S11-L0-040C</b> valmistajat: Grayhill, Inc. Kuvaus: ROTARY ENCODER OPTICAL 32PPR Varastossa: Out stock</p> <p><b>RFQ</b></p>
 <p><b>62S11-H9-040S</b> valmistajat: Grayhill, Inc. Kuvaus: ROTARY ENCODER OPTICAL 32PPR Varastossa: Out stock</p> <p><b>RFQ</b></p>	 <p><b>62S11-L0-040S</b> valmistajat: Grayhill, Inc. Kuvaus: ROTARY ENCODER OPT 32PPR 4" CBL Varastossa: Out stock</p> <p><b>RFQ</b></p>

**Tekijänoikeudet © 2020 luotettava elektronisten komponenttien jakelija - Ocean-Components.com**

Sähköposti: Info@Ocean-Components.com

Osoite: Room 2102, Connaught Commercial Building, 185 Wan Chai Rd, Wan Chai, Hong Kong

