

Panasonic

Panasonic

JQ1-18V-F

Osa numero:

JQ1-18V-F

Valmistaja / merkki:

Panasonic

Tuotteen Kuvaus

JQ RELAY 1 FORM C 18V

lomakkeissa:

 JQ1-18V-F.pdf

RoHS-tila

 Lyijytön / RoHS -yhteensopiva

Lähetys

Hong Kong

Lähetysreitti

DHL/Fedex/TNT/UPS/EMS

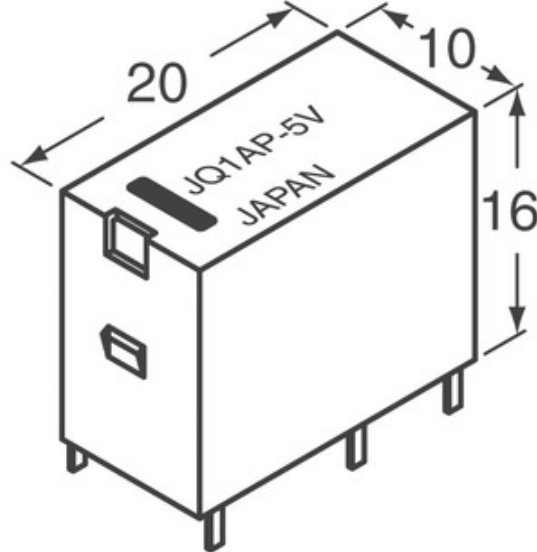
Kuva voi olla edustus. Katso tuotetiedot.











JQ1-18V-F: n tekniset tiedot

OSA NUMERO	JQ1-18V-F
VALMISTAJA	Panasonic
KUVAUS	JQ RELAY 1 FORM C 18V
LYIJYTÖN TILA / ROHS-TILA	Lyijytön / RoHS -yhteensopiva
TIETOLOMAKE	 JQ1-18V-F.pdf
SARJA	*
KOSTEUDEN HERKKYYS (MSL)	1 (Unlimited)
VALMISTAJAN TOIMITUSAIKA	12 Weeks
LYIJYTÖN TILA / ROHS-TILA	Lead free / RoHS Compliant
YKSITYISKOHTAINEN KUVAUS	Relay Coil

Liittyvät tunnisteet

Panasonic JQ1-18V-F	JQ1-18V-F-jakelija	JQ1-18V-F-toimittaja
JQ1-18V-F Hinta	JQ1-18V-F-kuvat	JQ1-18V-F-kuva
JQ1-18V-F PDF-tietosivu	JQ1-18V-F Lataa tietosivu	JQ1-18V-F-tietolomake
JQ1-18V-F-osake	Osta JQ1-18V-F	Osta Panasonic JQ1-18V-F
Panasonic JQ1-18V-F	Panasonic-toimittaja	Panasonic-jakelija
Panasonic JQ1-18V-F	Panasonic - Consumer Division JQ1-18V-F	Panasonic - Consumer Electronics Corp. JQ1-18V-F
Panasonic Battery Group JQ1-18V-F	Panasonic Electric Works - ACSD JQ1-18V-F	Panasonic Electronic Components - Semiconductor Pr JQ1-18V-F
Panasonic - ATG JQ1-18V-F	Panasonic - BSG JQ1-18V-F	Panasonic - DTG JQ1-18V-F
Panasonic Electric Works JQ1-18V-F	Panasonic Electronic Components JQ1-18V-F	Panasonic Industrial Automation Sales JQ1-18V-F
Panasonic Semiconductor JQ1-18V-F		

Liittyvät tuotteet

 <p>JQ1-6V-F valmistajat: Panasonic Kuvaus: RELAY GENERAL PURPOSE SPDT 5A 6V Varastossa: Out stock</p> <p>RFQ</p>	 <p>JQ1-5V valmistajat: Panasonic Kuvaus: RELAY GENERAL PURPOSE SPDT 5A 5V Varastossa: Out stock</p> <p>RFQ</p>
 <p>JQ1-3V valmistajat: Panasonic Kuvaus: RELAY GENERAL PURPOSE SPDT 5A 3V Varastossa: Out stock</p> <p>RFQ</p>	 <p>JQ1-24V valmistajat: Panasonic Kuvaus: RELAY GEN PURPOSE SPDT 5A 24V Varastossa: Out stock</p> <p>RFQ</p>
 <p>JQ1-5V-F valmistajat: Panasonic Kuvaus: RELAY GENERAL PURPOSE SPDT 5A 5V Varastossa: Out stock</p> <p>RFQ</p>	 <p>JQ1-48V valmistajat: Panasonic Kuvaus: RELAY GEN PURPOSE SPDT 5A 48V Varastossa: Out stock</p> <p>RFQ</p>
 <p>JQ1-48V-F valmistajat: Panasonic Kuvaus: RELAY GEN PURPOSE SPDT 5A 48V Varastossa: 100 pcs</p> <p>RFQ</p>	 <p>JQ1-6V valmistajat: Panasonic Kuvaus: RELAY GENERAL PURPOSE SPDT 5A 6V Varastossa: Out stock</p> <p>RFQ</p>
 <p>JQ1-12V valmistajat: Panasonic Kuvaus: RELAY GEN PURPOSE SPDT 5A 12V Varastossa: Out stock</p> <p>RFQ</p>	 <p>JQ1-18V valmistajat: Panasonic Kuvaus: RELAY GEN PURPOSE SPDT 5A 18V Varastossa: Out stock</p> <p>RFQ</p>
 <p>JQ1-24V-F valmistajat: Panasonic Kuvaus: RELAY GEN PURPOSE SPDT 5A 24V Varastossa: Out stock</p> <p>RFQ</p>	 <p>JQ1-12V-F valmistajat: Panasonic Kuvaus: RELAY GEN PURPOSE SPDT 5A 12V Varastossa: Out stock</p> <p>RFQ</p>

Tekijänoikeudet © 2020 luotettava elektronisten komponenttien jakelija - Ocean-Components.com

Sähköposti: Info@Ocean-Components.com

Osoite: Room 2102, Connaught Commercial Building, 185 Wan Chai Rd, Wan Chai, Hong Kong

