



IR Emitter and Detector Product Data Sheet

LTE-3276

Spec No.: DS50-2008-0044

Effective Date: 08/17/2012

Revision: A

LITE-ON DCC

RELEASE

BNS-OD-FC001/A4

FEATURES

- * HIGH SPEED
- * HIGH POWER
- * AVAILABLE FOR PULSE OPERATING
- * CLEAR TRANSPARENT COLOR PACKAGE

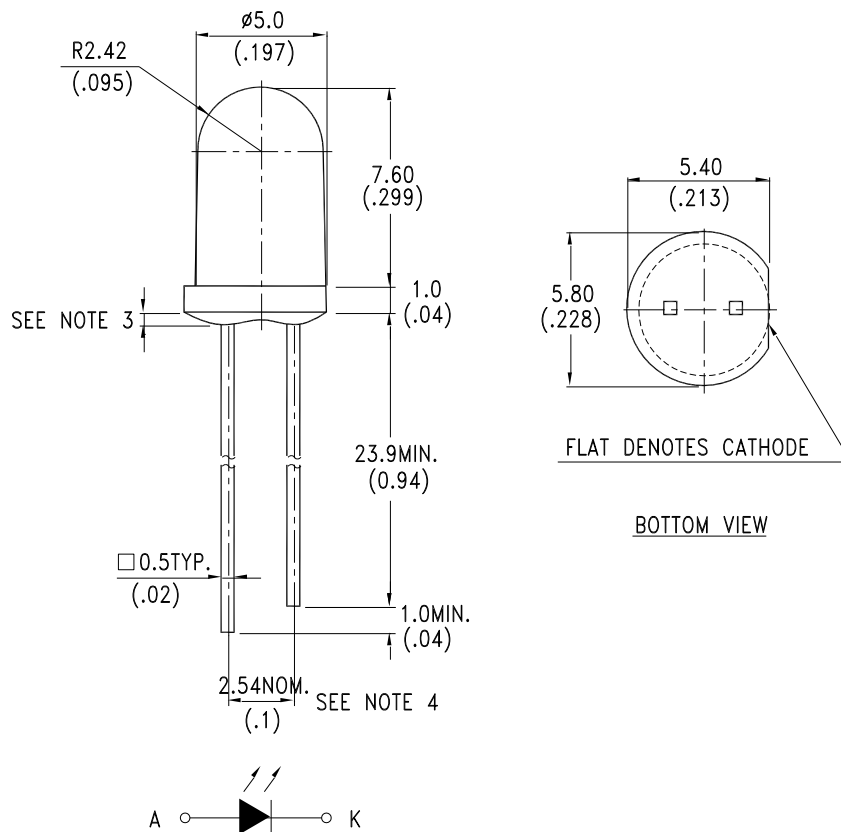
PACKAGE DIMENSIONS**NOTES:**

1. All dimensions are in millimeters (inches).
2. Tolerance is ± 0.25 mm (.010") unless otherwise noted.
3. Protruded resin under flange is 1.5mm (.059") max.
4. Lead spacing is measured where the leads emerge from the package.
5. Specifications are subject to change without notice.



LITE-ON TECHNOLOGY CORPORATION

Property of Lite-On Only

ABSOLUTE MAXIMUM RATINGS AT TA=25°C

PARAMETER	MAXIMUM RATING	UNIT
Power Dissipation	200	mW
Peak Forward Current (300pps, 10 μ s pulse)	1	A
Continuous Forward Current	100	mA
Reverse Voltage	5	V
Operating Temperature Range	-40°C to + 85°C	
Storage Temperature Range	-40°C to + 85°C	
Lead Soldering Temperature [1.6mm(.063") From Body]	260°C for 6 Seconds	

ELECTRICAL / OPTICAL CHARACTERISTICS AT TA=25°C

PARAMETER	SYMBOL	MIN.	TYP.	MAX.	UNIT	TEST CONDITION
Aperture Radiant Incidence	E _e	1.3	1.7	-	mW/cm ²	I _F = 20mA
Radiant Intensity	I _E	9.75	12.75	-	mW/sr	I _F = 20mA
Radiant Intensity	I _E	24	32	-	mW/sr	I _F = 50mA
Peak Emission Wavelength	λ_P	-	850	-	nm	I _F = 50mA
Spectral Line Half-Width	$\Delta \lambda$	-	40	-	nm	I _F = 50mA
Forward Voltage	V _F	-	1.49	1.80	V	I _F = 50mA
Forward Voltage	V _F	-	1.83	2.3	V	I _F = 200mA
Reverse Voltage	V _R	5	-	-	V	I _R = 10 μ A
Viewing Angle (See FIG.6)	2 $\theta_{1/2}$	-	50	-	deg.	I _F = 20mA

TYPICAL ELECTRICAL / OPTICAL CHARACTERISTICS CURVES

(25°C Ambient Temperature Unless Otherwise Noted)

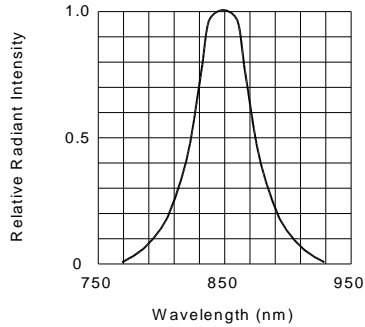

FIG.1 SPECTRAL DISTRIBUTION

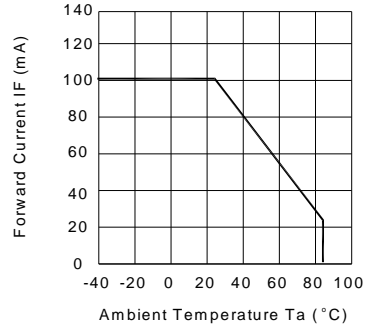

FIG.2 FORWARD CURRENT VS. AMBIENT TEMPERATURE

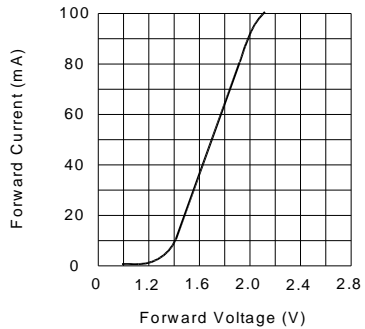

FIG.3 FORWARD CURRENT VS. FORWARD VOLTAGE

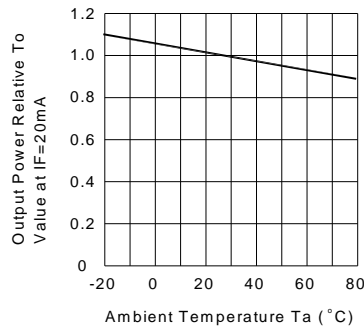

FIG.4 RELATIVE RADIANT INTENSITY VS. AMBIENT TEMPERATURE

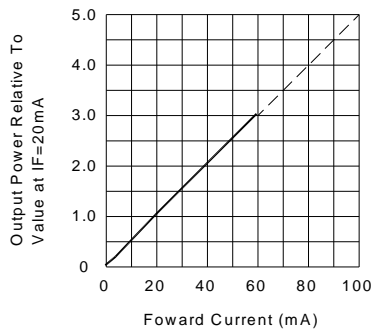

FIG.5 RELATIVE RADIANT INTENSITY VS. FORWARD CURRENT

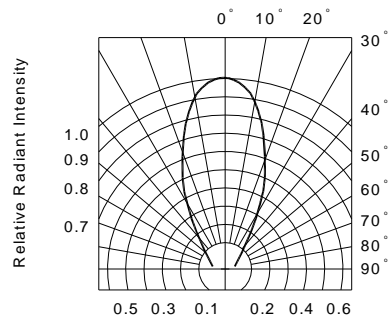

FIG.6 RADIATION DIAGRAM